

CLEAN AIR SOLUTIONS



AIRTECH JAPAN LTD.

14-9,1,IRIYA,TAITO-KU,TOKYO 110-8686 JAPAN
TEL +81-3-3872-6611 FAX +81-3-3872-6615

Antech Group Inc.

Tel/Fax: +86 532 8789 0321
Email: info@antechscientific.com
Web: www.antechscientific.com





COMPANY PROFILE

AIRTECH is No.1 company specializing in clean air system in Japan with 40 years expert knowledge & experience in clean air field. We have 15 domestic and 5 foreign firms (China, Singapore, Taiwan, Korea, India). Airtech provides a wide variety of products designed in many different functions and business segments.

Clean air system is introduced in various industries. Airtech has a large capacity for technology and wealth of experience for satisfaction of request specification and adapting to various installation environment. Airtech provides optimal solutions for customer requirements.

For more than 40 years, Airtech has contributed to the development of pharmacy, bio-medical research, bio industry, electronics industry and food industry by inventive solutions for air containment, contamination control and controlled environments. We realize high-degree cleanliness space with our unique technologies. We provide a customer with adequate after-sales service.

ADVANTAGE

A wide variety of products

Airtech is the only one company specializing in clean air system in Japan. Airtech provides a wide variety of products designed in many different functions, business segments and price ranges.

Technological capacity and wealth of experience

Clean air system is introduced in various industries. Airtech has a large capacity for technology and wealth of experience for satisfaction of request specification and adapting to various installation environment. Airtech provides optimal solutions for customer requirements.

Unique technologies, 100% guarantee

For more than 40 years, Airtech has contributed to the development of electronics industry, bio industry, food industry, and pharmacy by inventive solutions for air containment, contamination control and controlled environments. We realize high-degree cleanliness space with our unique technologies. We provide a customer with adequate after-sales service.

Global network

Airtech has 15 domestic and 5 foreign firms. (China, Singapore, Taiwan, Korea, India) Please consult with our firm about possibility of introduction of clean air system, if you are thinking of expanding your business abroad.



DIRECTORY



Company Profile	Airtech Clean Air	01
------------------------	-------------------	----



Biological Safety Cabinet	Introduction	04
	Main Construction	05
	Ergonomics Design	07
	Controlling System & Key Parts	09
	Alarms & Safety	10
	Airflow Pattern	11
	Services Access & Validation	12
	Quality Control	13
	Engineering Drawing	15
Specification	17	



Laminar Flow Cabinet	Desktop Type, VD/HD Series	19
	Standard Type, SW-CJ Series	21
	Neoteric Type, VS/HS Series	23
	Detached Type, VT/HT Series	25



AIRTECH Class II, Type A2/B2 Biosafety Cabinet

Biological safety cabinet is designed to protect operator, laboratory environment and samples from being exposed to the infective aerosol produced when the sample is bacteria strains, diagnostic material, and other infective subjects.

It provides the operators with a more comfortable and safer working condition. It is used in hospitals, disease prevention center, biological pharmacy and environment monitoring sections.



World-class brushless DC motor with automatic air volume compensation system;
Two independent sets of velocity sensors

Over-load protection for safety

LED Lamp providing sufficient and uniform lighting;
UV light running time can be set
Interlocked light and UV sterilizing

Dwyer (US brand) pressure gage

Access for water & gas tap

Removable one-piece spill retaining work zone with front grille, made in SUS304, easy to reach & cleaning

Drain valve for easy cleaning

Adjustable supporter to make sure cabinet is set firmly and horizontal



HEPA filter (H14 per EN1822) offer 99.99% efficiency at 0.3micron,creates ISO Class 3 clean zone; while ULPA filter as optional to provide 99.999% at 0.1 to 0.3 micron.

Angled down controller for easy reach and viewing

Waterproof Socket x 2

Japan lifting system for convenient operation

Curved corners for easy cleaning

Arm rest for comfortable working posture

Detachable frame stand

Castors for convenient movement

International Standards

	Biosafety Cabinets	Air Quality	Filtration	Electrical Safety
Standards Compliance	EN 12469, Europe JIS K 3800, Japan SFDA YY0569, China	ISO 14644.1, Class 4, Worldwide JIS B9920, Class 4, Japan JIS BS5295, Class 4, Japan US Fed Std 209E, Class 10 USA	ISO29463, Worldwide EN-1822, Europe EN13091, Europe IEST-RP-CC034.1, USA	EN-61010-1, Europe IEC61010-1, Worldwide

DC ECM motor

Automatic air volume compensation system for stable airflow
Low power consumption & reduced noise level

Dwyer brand (US imported) pressure gage

indicates real-time negative pressure between two sides of down flow filter.



Single piece wall & work tray:

- Large radius for easy cleaning
- Made in SUS304, rust free



Detachable stand

convenient installation & saving shipping space

- Adjustable feet to fit uneven floor
- Wheels for easy movement

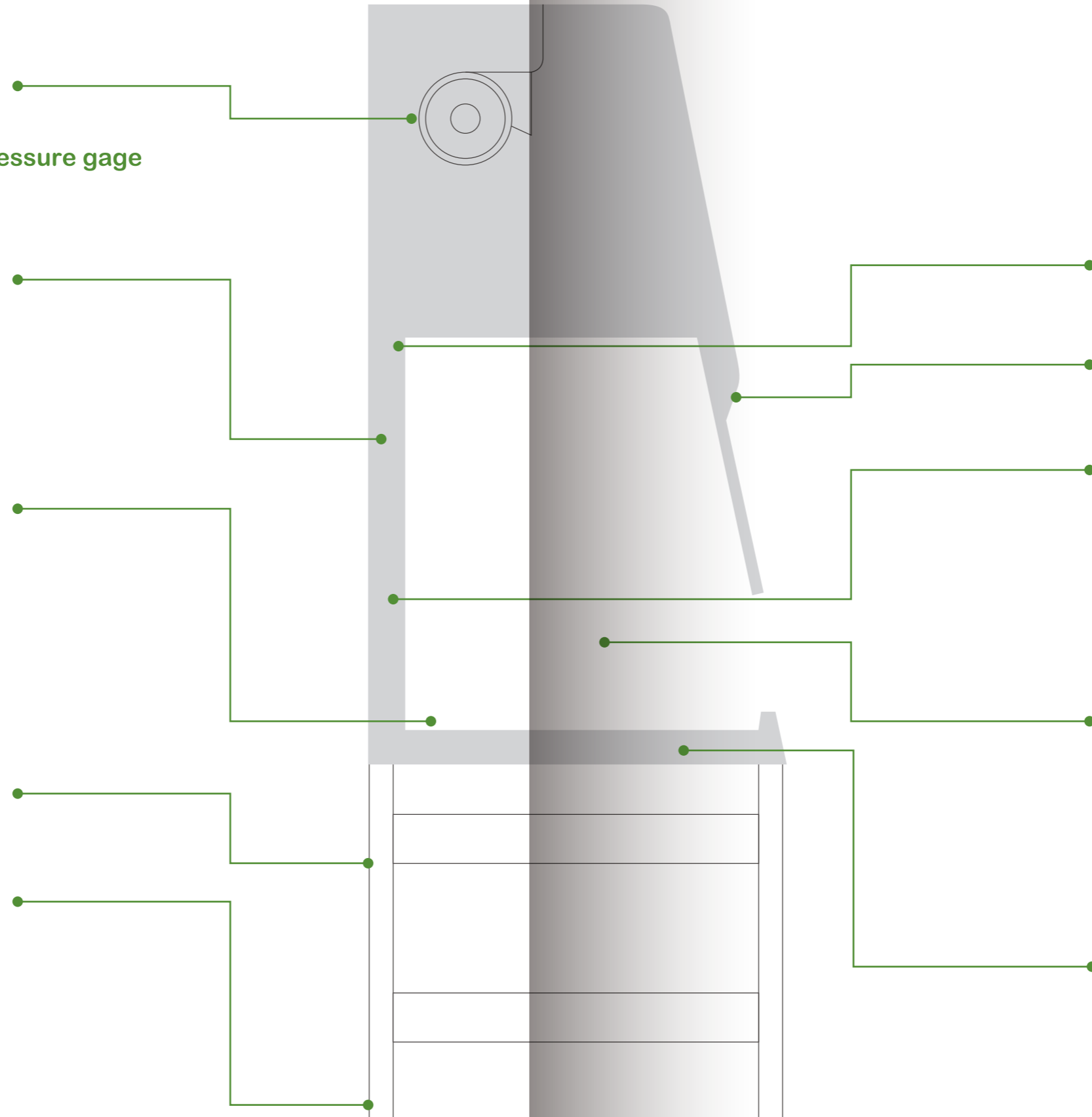

UV lamp for sterilization

Viewscreen

gradient of 10 Degree make it comfortable to operate

Receptacles :

- Waterproof
- Overload protection



Various valves for choice



Stainless steel armrest(Optional)

- Helps prevent grille blocking
- Comfortable working posture



AIRTECH Intelligence Controlling system

Control Panel

The large control panel displays valuable safety and performance data, and is within easy view and reach from a seated position.

The intuitive interface delivers a constant read-out of downflow and inflow velocities and overall cabinet performance status.

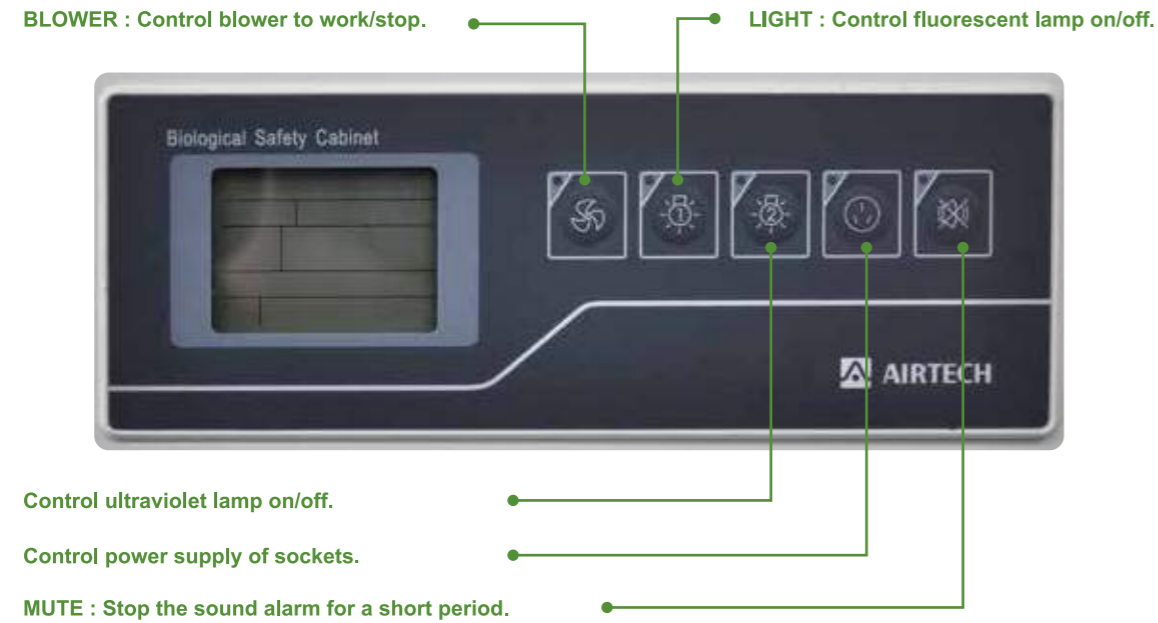

HEPA Filter

- HV brand filter, US imported
- HEPA filter, efficiency $\geq 99.995\%$ @ $0.3\mu\text{m}$ micron
- Removable uniform-flow film to protect filter from liquor



Velocity Meter:

- SHIBAURA brand (Japan imported) velocity meter for down flow
- E+E brand (Austria imported) velocity meter for exhaust airflow



Various Alarms:

- Inflow velocity alarm
- Exhausted airflow alarm
- The slide shutter height alarm
- Filter high-resistance alarm
- Fan failure alarm



Non-compromising Safety

“Zero Leakage” Negative Pressure Protection

AIRTECH unique “Zero Leakage” patent technology, providing a dynamic negative pressure environment. Imported automatic airflow compensation system to guarantee stable negative pressure

- Negative pressure
- Positive pressure

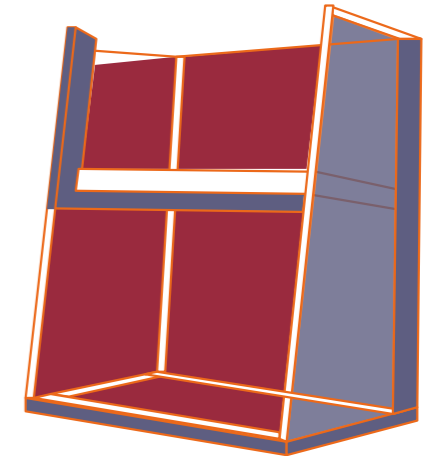

External air can't enter working area from front sash, protecting sample



Inner air not escape outside of outside, protecting operator



Airflow Pattern

Class II, Type A2

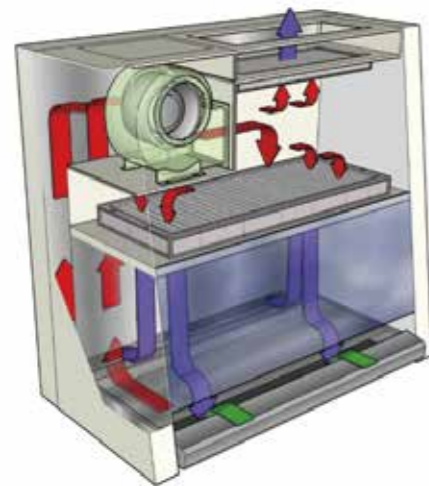

- H14-filtered air
- Unfiltered / potentially contaminated air
- Room air / Inflow air

Ambient air is pulled through front grille to create inflow, without going into the work surface. Inflow is joined by half of the downflow, to create front air curtain that is fine-tuned to create a large performance envelope. The combined air stream travels through the back air column towards the blower.

Approximately 30% of the air in the common plenum is exhausted through the HEPA filter to the room. The remaining 70% of the air is passed through the downflow HEPA filter and into the work area as a vertical laminar flow air to create ISO Class 4 work surface and prevents cross contamination.

Near the work surface, the downflow splits. About half goes to the front grille, and half goes to the rear grille. A small portion enters the side capture zones to prevent dead air corners (small blue arrows).

The design was optimized to give large performance envelope, that provides operator and product protection at wide inflow and downflow variation from the Nominal point.

Class II, Type B2

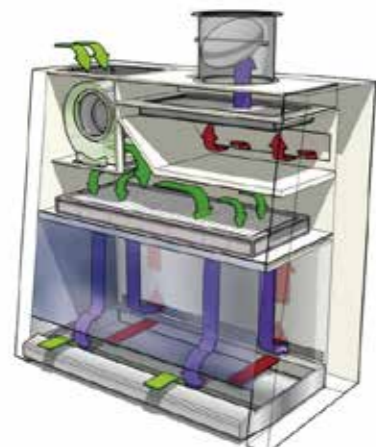

- H14-filtered air
- Unfiltered / potentially contaminated air
- Room air / Inflow air

Ambient air is pulled through the front grille to prevent contamination of the work surface and work product. The inflow does not mix with the clean air within the cabinet work zone.

Ambient air is taken in through a pre-filter at the top of the cabinet, and passes through the downflow HEPA filter, entering the work zone as laminar flow. The uniform, non-turbulent air stream protects against cross contamination within and throughout the work area.

Near the work surface, the downflow air stream splits with a portion moving toward the front air grille, and the remainder moving to the rear air grille.

A small portion of the HEPA filtered downflow enters the intake perforations at the side capture zones at a higher velocity (small blue arrows).

Services Access & Validation



Taking advantage of front open design with cover supporter, all cabinet main components are easily accessible from the front to allow for rapid service and minimal work disruption:

- Change of HEPA filters, LED lamps, UV lamps
- Adjustment or change of circuit boards and sensors
- Adjustment of alarms, fan speed control panel

Validation

Airtech offers professional services for all our equipment, including:

- factory acceptance testing,
- factory service training,
- customized product design,
- installation qualification
- operational qualification
- calibration

Comprehensive Performance Testing At AIRTECH



Downflow velocity testing

Working chamber velocity is key parameter to guarantee performance & safety. Velocity is tested strictly for each unit during QC procedure in AIRTECH factory. Downflow velocity of each point is recorded in factory testing report.



Inflow velocity testing

Airtech adapt direct inflow measurement method to test inflow velocity. Air volume meter is put to the center of front opening of cabinet, seal open area on either side of capture hood portion of direct inflow measurement. Inflow velocity is calculated based on 5 readings of meter.



Filter Leakage Detection

Using ATI brand (US imported) aerosol generator, able to scan passing rate of any point. Each AIRTECH cabinet is tested through the testing.



Biomedical verification (bacillus subtilis)

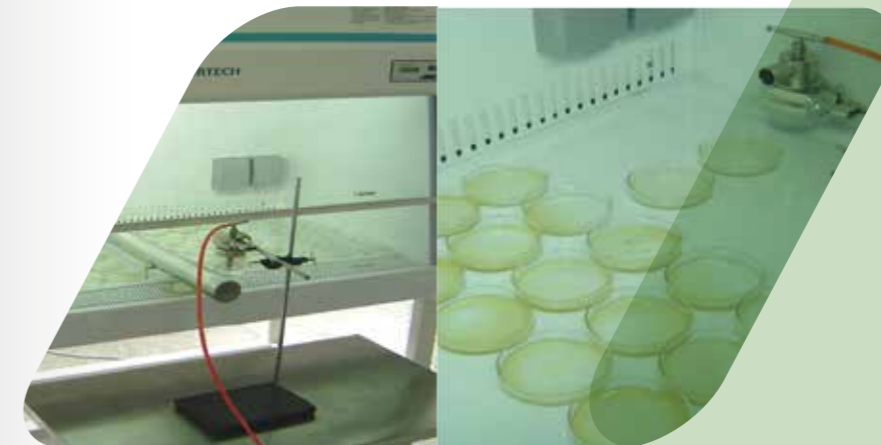

Class II Type A2 Biological Safety Cabinet Engineering Drawing

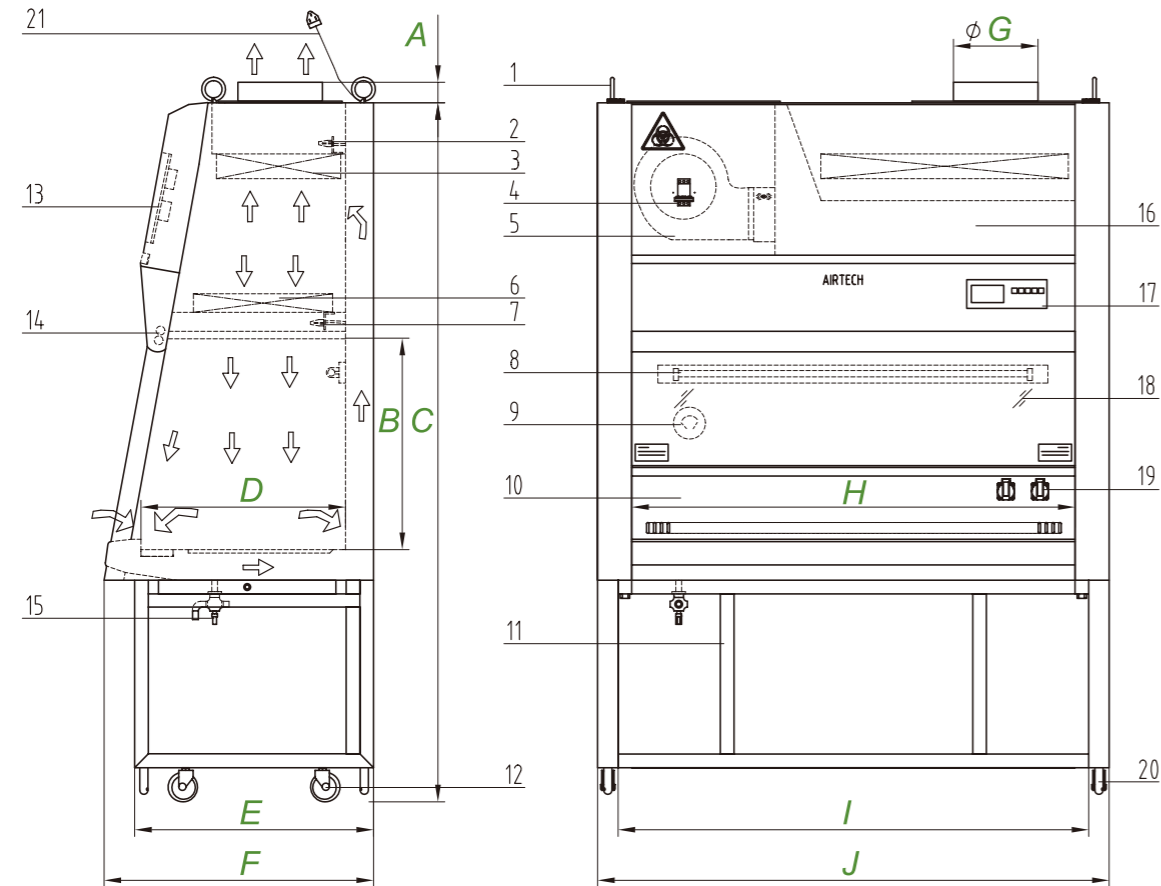

- 1. Eyebolt
- 2. Velocity sensor (Austria made, air exhaust)
- 3. HEPA filter, air exhaust
- 4. DC motor fan
- 5. Main power switch
- 6. HEPA filter, air supply
- 7. Velocity sensor (Japan made, air supply)
- 8. UV lamp
- 9. Dwyer differential pressure gauge (US made)
- 10. Work area
- 11. Detachable stand
- 12. Universal casters
- 13. Main power board
- 14. LED lamp
- 15. Drain valve
- 16. Main body
- 17. Control panel
- 18. Sliding door
- 19. Sockets
- 20. Adjustable feet
- 21. Power cord

Model	Dimensions in mm									
	A	B	C	D	E	F	G	H	I	J
BSC-1301IIA2	60	620	2050	600	700	790	250	1270	1380	1500
BSC-1302IIA2	60	620	2050	600	700	790	250	1270	1380	1500

Certification

At AIRTECH, we know how important to design a product in compliance with current worldwide safety standards. The class II type A2 biological safety cabinet is certified as per CE, EN12469 and CFDA. The model certified as per NSF49 is also available.



EN12469

AIRTECH Class II type A2 biological safety cabinets are independently tested and certified to EN12469 standard by TÜV Nord, a leading testing agency in Europe



NSF/ANSI 49

AIRTECH BSC-1301IIA2 is independently tested and certified to NSF/ANSI 49, By NSF International, a leading testing agency in the USA.



YY0569

AIRTECH, as a leading dafter for Chinese BSC standard, independently tested and certified to YY0569

TECHNICAL SPECIFICATIONS

Model		BSC-1301IIA2	BSC-1302IIA2
Dimensions	Nominal Size	4 feet	
	Usable Work Area	0.762 m ²	
	Stand Height	720 (mm) 28.4 (in)	
	Internal Dimensions (W x D x H)	1270*600*620 (mm)	50*23.6*24.4 (in)
	External Dimensions (W x D x H)	1500*790*2050 (mm)	59.1*31.1*80.7 (in)
	Plywoond Packing Dimensions (W x D x H)	1600*1070*1590 (mm)	63*42.1*62.6 (in)
Airflow	Type	Class II, Type A2	
	Exhaust Direction	Top Exhaust	
	Airflow Pattern (recirculation / exhaust)	70% / 30%	
	Avarage Inflow Velocity	0.54m/s	
	Average Downflow Velocity	0.35m/s	
	Inflow Airflow Volume	617 m ³ /h	
	Downflow Airflow Volume	896 m ³ /h	
	Exhaust Airflow Volume	617 m ³ /h	
	Velocity Meter Accuracy	0.001m/s	
	Pressure Gage	Dwyer Brand	
Cabinet Construction	Work Zone	Stainless Steel SUS304	
	Main Body	Electro-galvanized steel with white oven-baked powder-coated finish	
	Sash Glass Thickness	5mm	
	Sash Glass Type	Tempered Glass, UV-proof	
	Sash Window Maximum Working Opening	250 (mm) 9.85 (in)	
	Sash Window Maximum Opening	540 (mm) 21.3 (in)	
	Illumination (Lx)	≥1000	
	Noise (dB)	≤64	
Cleanliness	Cleanliness	HEPA: ISO Class 5	
	Filtration Efficiency	HEPA:≥99.995%,@0.3 μm	
	Total colony in impaction sampler(Operator Protection)	≤10CFU./Time	
	Total colony in slit type sampler(Operator Protection)	≤5CFU./Time	
	Total colony in culture dish (Product Protection)	≤5CFU./Time	
Controller	Total colony in culture dish (Cross Contamination)	≤2CFU./Time	
	Display	LCD Screen	
Electrical Data	UV Timer	Yes	
	Overload protector	Yes	
	Power Consumption (KW.h/h)	0.8 (with spare socket)	0.4 (with spare socket)
	Power (W)	800 (with spare socket)	400 (with spare socket)
Power Supply	Electrical Current (A)	7 (with spare socket)	3 (with spare socket)
	AC115V,1Φ,50HZ	Yes	/
Weight	AC220V,1Φ,60HZ	/	Yes
	Net Weight(kg)	300	
Alarm	Gross Weight, Plywood Packing (kg)	405	
	Alarm Type	Sound+Flash	
	Sash window height limit	Yes	
	Filter Blocked	Yes	
	Filter Shattured	Yes	
	Filter Lifetime Remind	Yes	
	Inflow Velocity	Yes	
Filter	Downflow Velocity	Yes	
	Downflow	HEPA:≥99.995%,@0.3 μm;H14 per EN1822	
Accessories	Exhaust	HEPA:≥99.995%,@0.3 μm;H14 per EN1822	
	LED Lamp	Illuminance ≥1000Lx	
	UV Lamp	λ≥254nm,Irradiation intensity≥400mW/ m ²	
	Receptacle (pieces/Power/Current)	2 pcs/115V/2A	2 pcs/220V/2A
	Gas Valve	Optional	
	Water Valve	Optional	
	Vaccum Valve	Optional	
	IV Bar	Optional	
	Stainless Steel Arm Rest	Optional	
	Detachable Stand	Yes	
Certificate	Adjustable Foot	Yes	
	Wheels	Yes	
		NSF49/UL	

Desk-top Laminar Flow Cabinet Vertical Type, VD Series



Features:

- Space-saving desk-top type with compact design
- SUS304 working area
- Adjustable fan unit & one-button velocity selection
- High efficiency & low power consumption

Model		VD-650	VD-650-U	VD-1320	VD-1320-U
Constructions	Airflow Type	Vertical Airflow	Vertical Airflow	Vertical Airflow	Vertical Airflow
	Side Wall Material	Float Glass	Float Glass	Float Glass	Float Glass
	Working Zone Material	SUS304	SUS304	SUS304	SUS304
	Operation side/Operator Number	Single-side/Single-operator	Single-side/Single-operator	Single-side/Single-operator	Single-side/Single-operator
Performance	Cleanliness Class	ISO Class 5, FED 209 E Class 100	ISO Class 5, FED 209 E Class 100	ISO Class 5, FED 209 E Class 100	ISO Class 5, FED 209 E Class 100
	Filter Efficiency	≥99.99%(@0.3μm)	≥99.99%(@0.3μm)	≥99.99%(@0.3μm)	≥99.99%(@0.3μm)
	Velocity (m/s)	≥0.3m/s(Adjustable)	≥0.3m/s(Adjustable)	≥0.3m/s(Adjustable)	≥0.3m/s(Adjustable)
	Illumination (Lx)	≥300	≥300	≥300	≥300
Controller	Display	LED	LED	LED	LED
	Power Switch	Yes	Yes	Yes	Yes
Electrical Date	Voltage/Frequency (V/Hz)	AC220V, 50HZ, 1Φ	AC220V, 50HZ, 1Φ	AC220V, 50HZ, 1Φ	AC220V, 50HZ, 1Φ
	Power Consumption KW.h/h	0.3	0.3	0.6	0.6
	Power (W)	250	250	500	500
	Current (A)	3	3	6	6
Weight	Net Weight (kg)	60	60	90	90
Dimensions	Working Dimension(W*D*H)(mm)	615*495*500	615*495*500	1240*480*550	1240*480*550
	External Dimension(W*D*H)(mm)	650*535*835	650*535*835	1320*585*950	1320*585*950
Accessories	Lamp	LED, 7W*1	LED, 7W*1	LED, 7W*2	LED, 7W*2
	UV Lamp	N/A	As standard, 8W*1	N/A	As standard, 8W*2
	Socket	N/A	N/A	N/A	N/A

Desk-top Laminar Flow Cabinet Horizontal Type, HD Series



Features:

- Space-saving desk-top type with compact design
- Open type large air exhaust area for airflow uniformity
- SUS304 working area
- Adjustable fan unit & one-button velocity selection
- High efficiency & low power consumption

Model		HD-650	HD-650-U	HD-1220	HD-1220-U
Constructions	Airflow Type	Horizontal Airflow	Horizontal Airflow	Horizontal Airflow	Horizontal Airflow
	Side Wall Material	Float Glass	Float Glass	Float Glass	Float Glass
	Working Zone Material	SUS304	SUS304	SUS304	SUS304
	Operation side/Operator Number	Single-side/Single-operator	Single-side/Single-operator	Single-side/Single-operator	Single-side/Single-operator
Performance	Cleanliness Class	ISO Class 5, FED 209 E Class 100	ISO Class 5, FED 209 E Class 100	ISO Class 5, FED 209 E Class 100	ISO Class 5, FED 209 E Class 100
	Filter Efficiency	≥99.99%(@0.3μm)	≥99.99%(@0.3μm)	≥99.99%(@0.3μm)	≥99.99%(@0.3μm)
	Velocity (m/s)	≥0.3m/s(Adjustable)	≥0.3m/s(Adjustable)	≥0.3m/s(Adjustable)	≥0.3m/s(Adjustable)
	Illumination (Lx)	≥300	≥300	≥300	≥300
Controller	Display	LED	LED	LED	LED
	Power Switch	Yes	Yes	Yes	Yes
Electrical Date	Voltage/Frequency (V/Hz)	AC220V, 50HZ, 1Φ	AC220V, 50HZ, 1Φ	AC220V, 50HZ, 1Φ	AC220V, 50HZ, 1Φ
	Power Consumption KW.h/h	0.3	0.3	0.6	0.6
	Power (W)	250	250	500	500
	Current (A)	3	3	6	6
Weight	Net Weight (kg)	55	55	85	85
Dimensions	Working Dimension(W*D*H)(mm)	615*400*535	615*400*535	1120*490*575	1120*490*575
	External Dimension(W*D*H)(mm)	650*680*625	650*680*625	1220*650*920	1220*650*920
Accessories	Lamp	LED, 7W*1	LED, 7W*1	LED, 7W*2	LED, 7W*2
	UV Lamp	N/A	As standard, 1 pc, 8W	N/A	As standard, 8W*2
	Socket	N/A	N/A	N/A	N/A

Standard Laminar Flow Cabinet Vertical Type, SW-CJ Series



Features:

- Main HEPA filter efficiency $\geq 99.99\%$ (@0.3 μm)
- Per-filter to prolong lifetime of main filter
- Tempered glass window with Japan lifting system
- SUS304 working area for easy cleaning
- Adjustable fan unit & one-button velocity selection
- Inter-locking system for illuminating light & UV lamp
- Universal wheel & foot

Model	SW-CJ-1F	SW-CJ-1FD	SW-CJ-2F	SW-CJ-2FD	
Constructions	Airflow Type	Vertical Airflow	Vertical Airflow	Vertical Airflow	Vertical Airflow
	Side Wall Material	Coated Steel+Float Glass	Coated Steel+Float Glass	Coated Steel	Coated Steel
	Working Zone Material	SUS304	SUS304	SUS304	SUS304
	Max. Working Height (mm)	200	200	200	200
	Max. Opening Height (mm)	460	460	460	460
	Working Zone Height (mm)	780	780	780	780
	Operation side/Operator Number	Double-side/Single-operator	Single-side/Single-operator	Double-side/Double-operator	Single-side/Double-operator
Performance	Cleanliness Class	ISO Class 5, FED 209 E Class 100	ISO Class 5, FED 209 E Class 100	ISO Class 5, FED 209 E Class 100	ISO Class 5, FED 209 E Class 100
	Filter Efficiency	$\geq 99.99\%$ (@0.3 μm)	$\geq 99.99\%$ (@0.3 μm)	$\geq 99.99\%$ (@0.3 μm)	$\geq 99.99\%$ (@0.3 μm)
	Velocity (m/s)	$\geq 0.3\text{m/s}$ (Adjustable)	$\geq 0.3\text{m/s}$ (Adjustable)	$\geq 0.3\text{m/s}$ (Adjustable)	$\geq 0.3\text{m/s}$ (Adjustable)
	Illumination (lx)	≥ 300	≥ 300	≥ 300	≥ 300
Controller	Display	LED	LED	LED	LED
	Power Switch	Yes	Yes	Yes	Yes
Electrical Data	Voltage/Frequency (V/Hz)	AC220V, 50HZ, 1 Φ	AC220V, 50HZ, 1 Φ	AC220V, 50HZ, 1 Φ	AC220V, 50HZ, 1 Φ
	Power Consumption KW.h/h	0.3	0.3	0.6	0.6
	Power (W)	250	250	500	500
	Current (A)	5	5	6	6
Weight	Net Weight (kg)	130	130	170	170
	Working Dimension(W*D*H)(mm)	870*690*520	870*690*520	1360*690*520	1360*690*520
Dimensions	External Dimension(W*D*H)(mm)	1010*750*1600	1010*730*1600	1500*750*1600	1500*730*1600
	Caster	4,2 lockable	4,2 lockable	4,2 lockable	4,2 lockable
Accessories	Foot Supporter	N/A	N/A	N/A	N/A
	Lamp	LED, 7W*1	LED, 7W*1	LED, 7W*2	LED, 7W*2
	UV Lamp	N/A	As standard, 8W*1	N/A	As standard, 8W*2
	Socket	1/500W/3A	1/500W/3A	1/500W/3A	1/500W/3A
	Certificate	CE	Yes	Yes	Yes

Standard Laminar Flow Cabinet Horizontal Type, SW-CJ Series



Features:

- Main HEPA filter efficiency $\geq 99.99\%$ (@0.3 μm)
- Per-filter to prolong lifetime of main filter
- SUS304 working area for easy cleaning
- Adjustable fan unit & one-button velocity selection
- Inter-locking system for illuminating light & UV lamp
- Universal wheel & foot

Model	SW-CJ-1B	SW-CJ-1BU	SW-CJ-1C	SW-CJ-1CU	
Constructions	Airflow Type	Horizontal Airflow	Horizontal Airflow	Horizontal Airflow	Horizontal Airflow
	Side Wall Material	Float Glass	Float Glass	Float Glass	Float Glass
	Working Zone Material	SUS304	SUS304	SUS304	SUS304
	Max. Working Height (mm)	N/A	N/A	N/A	N/A
	Max. Opening Height (mm)	N/A	N/A	N/A	N/A
	Working Zone Height (mm)	750	750	750	750
	Operation side/Operator Number	Single-side/Single-operator	Single-side/Single-operator	Single-side/Double-operator	Single-side/Double-operator
Performance	Cleanliness Class	ISO Class 5, FED 209 E Class 100	ISO Class 5, FED 209 E Class 100	ISO Class 5, FED 209 E Class 100	ISO Class 5, FED 209 E Class 100
	Filter Efficiency	$\geq 99.99\%$ (@0.3 μm)	$\geq 99.99\%$ (@0.3 μm)	$\geq 99.99\%$ (@0.3 μm)	$\geq 99.99\%$ (@0.3 μm)
	Velocity (m/s)	$\geq 0.3\text{m/s}$ (Adjustable)	$\geq 0.3\text{m/s}$ (Adjustable)	$\geq 0.3\text{m/s}$ (Adjustable)	$\geq 0.3\text{m/s}$ (Adjustable)
	Illumination (lx)	≥ 300	≥ 300	≥ 300	≥ 300
Controller	Display	LED	LED	LED	LED
	Power Switch	Yes	Yes	Yes	Yes
Electrical Data	Voltage/Frequency (V/Hz)	AC220V, 50HZ, 1 Φ	AC220V, 50HZ, 1 Φ	AC220V, 50HZ, 1 Φ	AC220V, 50HZ, 1 Φ
	Power Consumption KW.h/h	0.3	0.3	0.6	0.6
	Power (W)	250	250	500	500
	Current (A)	5	5	6	6
Weight	Net Weight (kg)	100	100	160	160
	Working Dimension(W*D*H)(mm)	820*480*600	820*480*600	1680*480*600	1680*480*600
Dimensions	External Dimension(W*D*H)(mm)	900*700*1450	900*700*1450	1760*700*1450	1760*700*1450
	Caster	4,2 lockable	4,2 lockable	4,2 lockable	4,2 lockable
Accessories	Foot Supporter	N/A	N/A	N/A	N/A
	Lamp	Fluorescent Lamp, 18W*1	Fluorescent Lamp, 18W*1	Fluorescent Lamp, 36W*1	Fluorescent Lamp, 36W*1
	UV Lamp	N/A	As standard, 1 pc, 20W	N/A	As standard, 1 pc, 40W
	Socket	1/500W/3A	1/500W/3A	1/500W/3A	1/500W/3A
	Certificate	CE	Yes	Yes	Yes

Neoteric Laminar Flow Cabinet Vertical Type, VS Series



Features:

- Per-filter to prolong lifetime of main HEPA filter
- Tempered glass window with Japan lifting system
- SUS304 working area with curving front
- Adjustable fan unit & one-button velocity selection
- Inter-locking system for illuminating light & UV lamp
- Universal wheel & foot

Model	VS-840K	VS-840K-U	VS-1300L	VS-1300L-U	
Constructions	Airflow Type	Vertical Airflow	Vertical Airflow	Vertical Airflow	Vertical Airflow
	Side Wall Material	Tempered Glass	Tempered Glass	Tempered Glass	Tempered Glass
	Working Zone Material	SUS304	SUS304	SUS304	SUS304
	Max. Working Height (mm)	200	200	200	200
	Max. Opening Height (mm)	480	480	630	630
	Working Zone Height (mm)	770	770	770	770
	Operation side/Operator Number	Single-side/Single-operator	Single-side/Single-operator	Single-side/Double-operator	Single-side/Double-operator
Performance	Cleanliness Class	ISO Class 5, FED 209 E Class 100	ISO Class 5, FED 209 E Class 100	ISO Class 5, FED 209 E Class 100	ISO Class 5, FED 209 E Class 100
	Filter Efficiency	≥99.99%(@0.3μm)	≥99.99%(@0.3μm)	≥99.99%(@0.3μm)	≥99.99%(@0.3μm)
	Velocity (m/s)	≥0.3m/s(Adjustable)	≥0.3m/s(Adjustable)	≥0.3m/s(Adjustable)	≥0.3m/s(Adjustable)
	Illumination (Lx)	≥300	≥300	≥300	≥300
Controller	Display	LED	LED	LED	LED
	Power Switch	Yes	Yes	Yes	Yes
Electrical Data	Voltage/Frequency (V/Hz)	AC220V, 50HZ, 1Φ	AC220V, 50HZ, 1Φ	AC220V, 50HZ, 1Φ	AC220V, 50HZ, 1Φ
	Power Consumption KW.h/h	0.3	0.3	0.6	0.6
	Power (W)	250	250	500	500
	Current (A)	5	5	6	6
Weight	Net Weight (kg)	145	145	200	200
Dimensions	Working Dimension(W*D*H)(mm)	680*650*570	680*650*570	1140*650*720	1140*650*720
	External Dimension(W*D*H)(mm)	840*825*1625	840*825*1625	1300*825*1175	1300*825*1175
Accessories	Caster	4, not lockable	4, not lockable	4, not lockable	4, not lockable
	Foot Supporter	Yes	Yes	Yes	Yes
	Lamp	Fluorescent Lamp, 18W*1	Fluorescent Lamp, 18W*1	Fluorescent Lamp, 30W*1	Fluorescent Lamp, 30W*1
	UV Lamp	N/A	As standard, 20W*1	N/A	As standard, 30W*1
	Socket	1/500W/3A	1/500W/3A	1/500W/3A	1/500W/3A
Certificate	CE	Yes	Yes	Yes	Yes

Neoteric Laminar Flow Cabinet Horizontal Type, HS Series



Features:

- Main HEPA filter efficiency ≥99.99%(@0.3μm)
- Per-filter to prolong lifetime of main filter
- SUS304 working area for easy cleaning
- Adjustable fan unit & one-button velocity selection
- Inter-locking system for illuminating light & UV lamp
- Universal wheel & foot

Model	HS-840	HS-840-U	HS-1300	HS-1300-U	
Constructions	Airflow Type	Horizontal Airflow	Horizontal Airflow	Horizontal Airflow	Horizontal Airflow
	Side Wall Material	Tempered Glass	Tempered Glass	Tempered Glass	Tempered Glass
	Working Zone Material	SUS304	SUS304	SUS304	SUS304
	Max. Working Height (mm)	N/A	N/A	N/A	N/A
	Max. Opening Height (mm)	N/A	N/A	N/A	N/A
	Working Zone Height (mm)	770	770	770	770
	Operation side/Operator Number	Single-side/Single-operator	Single-side/Single-operator	Single-side/Double-operator	Single-side/Double-operator
Performance	Cleanliness Class	ISO Class 5, FED 209 E Class 100	ISO Class 5, FED 209 E Class 100	ISO Class 5, FED 209 E Class 100	ISO Class 5, FED 209 E Class 100
	Filter Efficiency	≥99.99%(@0.3μm)	≥99.99%(@0.3μm)	≥99.99%(@0.3μm)	≥99.99%(@0.3μm)
	Velocity (m/s)	≥0.3m/s(Adjustable)	≥0.3m/s(Adjustable)	≥0.3m/s(Adjustable)	≥0.3m/s(Adjustable)
	Illumination (Lx)	≥300	≥300	≥300	≥300
Controller	Display	LED	LED	LED	LED
	Power Switch	Yes	Yes	Yes	Yes
Electrical Data	Voltage/Frequency (V/Hz)	AC220V, 50HZ, 1Φ	AC220V, 50HZ, 1Φ	AC220V, 50HZ, 1Φ	AC220V, 50HZ, 1Φ
	Power Consumption KW.h/h	0.3	0.3	0.6	0.6
	Power (W)	250	250	500	500
	Current (A)	5	5	6	6
Weight	Net Weight (kg)	125	125	170	170
Dimensions	Working Dimension(W*D*H)(mm)	720*650*570	720*650*570	1180*650*570	1180*650*570
	External Dimension(W*D*H)(mm)	840*825*1430	840*825*1430	1300*825*1430	1300*825*1430
Accessories	Caster	4, not lockable	4, not lockable	4, not lockable	4, not lockable
	Foot Supporter	4	4	4	4
	Lamp	Fluorescent Lamp, 18W*2	Fluorescent Lamp, 18W*1	Fluorescent Lamp, 30W*2	Fluorescent Lamp, 30W*1
	UV Lamp	N/A	As standard, 1 pc, 20W	N/A	As standard, 1 pc, 30W
	Socket	1/500W/3A	1/500W/3A	1/500W/3A	1/500W/3A
Certificate	CE	Yes	Yes	Yes	Yes

Detached Laminar Flow Cabinet Vertical Type, VT Series



Features:

- Detachable working table for easily moving samples
- HEPA filter efficiency $\geq 99.99\%$ (@0.3 μm)
- Per-filter to prolong lifetime of main filter
- Tempered glass window with Japan lifting system
- SUS304 working area for easy cleaning
- Adjustable fan unit & one-button velocity selection
- Inter-locking system for illuminating light & UV lamp

Model	VT-840K	VT-840K-U	VT-1300L	VT-1300L-U	
Constructions	Airflow Type	Vertical Airflow	Vertical Airflow	Vertical Airflow	Vertical Airflow
	Side Wall Material	Tempered Glass	Tempered Glass	Tempered Glass	Tempered Glass
	Working Zone Material	SUS304	SUS304	SUS304	SUS304
	Max. Working Height (mm)	200	200	200	200
	Max. Opening Height (mm)	480	480	630	630
	Working Zone Height (mm)	770	770	770	770
	Operation side/Operator Number	Single-side/Single-operator	Single-side/Single-operator	Single-side/Double-operator	Single-side/Double-operator
Performance	Cleanliness Class	ISO Class 5, FED 209 E Class 100	ISO Class 5, FED 209 E Class 100	ISO Class 5, FED 209 E Class 100	ISO Class 5, FED 209 E Class 100
	Filter Efficiency	$\geq 99.99\%$ (@0.3 μm)	$\geq 99.99\%$ (@0.3 μm)	$\geq 99.99\%$ (@0.3 μm)	$\geq 99.99\%$ (@0.3 μm)
	Velocity (m/s)	$\geq 0.3\text{m/s}$ (Adjustable)	$\geq 0.3\text{m/s}$ (Adjustable)	$\geq 0.3\text{m/s}$ (Adjustable)	$\geq 0.3\text{m/s}$ (Adjustable)
	Illumination (Lx)	≥ 300	≥ 300	≥ 300	≥ 300
Controller	Display	LED	LED	LED	LED
	Power Switch	Yes	Yes	Yes	Yes
Electrical Date	Voltage/Frequency (V/Hz)	AC220V, 50HZ, 1 Φ	AC220V, 50HZ, 1 Φ	AC220V, 50HZ, 1 Φ	AC220V, 50HZ, 1 Φ
	Power Consumption KW.h/h	0.3	0.3	0.6	0.6
	Power (W)	250	250	500	500
	Current (A)	5	5	6	6
Weight	Net Weight (kg)	165	165	240	240
Dimensions	Working Dimension(W*D*H)(mm)	680*650*570	680*650*570	1140*650*720	1140*650*720
	External Dimension(W*D*H)(mm)	840*825*1625	840*825*1625	1300*825*1775	1300*825*1775
Accessories	Caster	4, not lockable	4, not lockable	4, not lockable	4, not lockable
	Foot Supporter	Yes	Yes	Yes	Yes
	Lamp	Fluorescent Lamp, 18W*1	Fluorescent Lamp, 18W*1	Fluorescent Lamp, 30W*1	Fluorescent Lamp, 30W*1
	UV Lamp	N/A	As standard, 20W*1	N/A	As standard, 30W*1
	Socket	1/500W/3A	1/500W/3A	1/500W/3A	1/500W/3A

Detached Laminar Flow Cabinet Horizontal Type, HD Series



Features:

- Detachable working table for easily moving samples
- HEPA filter efficiency $\geq 99.99\%$ (@0.3 μm)
- Per-filter to prolong lifetime of main filter
- SUS304 working area for easy cleaning
- Adjustable fan unit & one-button velocity selection
- Inter-locking system for illuminating light & UV lamp

Model	HT-840	HT-840-U	HT-1300	HT-1300-U	
Constructions	Airflow Type	Horizontal Airflow	Horizontal Airflow	Horizontal Airflow	Horizontal Airflow
	Side Wall Material	Tempered Glass	Tempered Glass	Tempered Glass	Tempered Glass
	Working Zone Material	SUS304	SUS304	SUS304	SUS304
	Max. Working Height (mm)	N/A	N/A	N/A	N/A
	Max. Opening Height (mm)	N/A	N/A	N/A	N/A
	Working Zone Height (mm)	770	770	770	770
	Operation side/Operator Number	Single-side/Single-operator	Single-side/Single-operator	Single-side/Double-operator	Single-side/Double-operator
Performance	Cleanliness Class	ISO Class 5, FED 209 E Class 100	ISO Class 5, FED 209 E Class 100	ISO Class 5, FED 209 E Class 100	ISO Class 5, FED 209 E Class 100
	Filter Efficiency	$\geq 99.99\%$ (@0.3 μm)	$\geq 99.99\%$ (@0.3 μm)	$\geq 99.99\%$ (@0.3 μm)	$\geq 99.99\%$ (@0.3 μm)
	Velocity (m/s)	$\geq 0.3\text{m/s}$ (Adjustable)	$\geq 0.3\text{m/s}$ (Adjustable)	$\geq 0.3\text{m/s}$ (Adjustable)	$\geq 0.3\text{m/s}$ (Adjustable)
	Illumination (Lx)	≥ 300	≥ 300	≥ 300	≥ 300
Controller	Display	LED	LED	LED	LED
	Power Switch	Yes	Yes	Yes	Yes
Electrical Date	Voltage/Frequency (V/Hz)	AC220V, 50HZ, 1 Φ	AC220V, 50HZ, 1 Φ	AC220V, 50HZ, 1 Φ	AC220V, 50HZ, 1 Φ
	Power Consumption KW.h/h	0.3	0.3	0.6	0.6
	Power (W)	250	250	500	500
	Current (A)	5	5	6	6
Weight	Net Weight (kg)	150	150	190	190
Dimensions	Working Dimension(W*D*H)(mm)	680*650*570	680*650*570	1140*650*570	1140*650*570
	External Dimension(W*D*H)(mm)	840*825*1430	840*825*1430	1300*825*1430	1300*825*1430
Accessories	Caster	4, not lockable	4, not lockable	4, not lockable	4, not lockable
	Foot Supporter	4	4	4	4
	Lamp	Fluorescent Lamp, 18W*2	Fluorescent Lamp, 18W*1	Fluorescent Lamp, 30W*2	Fluorescent Lamp, 30W*1
	UV Lamp	N/A	As standard, 1 pc, 20W	N/A	As standard, 1 pc, 30W
	Socket	1/500W/3A	1/500W/3A	1/500W/3A	1/500W/3A